













**META Washstand fitting with electronic opening and closing function without pop-up waste - Chrome**

META

44 511 660



- Infrared sensor technology
- 125mm projection
- height of mixer 140 mm
- height up to aerator 52 mm
- hole diameter 35 mm
- fixed spout
- max. flow 5.7 l/min
- circular, air-enriched flow
- suitable for thermal disinfection
- Automatic shut-off after pre-set time is reached
- Direct temperature control at faucet
- Plug-in power supply included
- lead-free
- 2x screw-in M 8 x 1 pressure hose, leak-tested
- This product can help a building meet the requirements of Green Building Rating Systems, e.g. LEED®, BREEAM®, DGNB

|   |                                |               |
|---|--------------------------------|---------------|
|    | Chrome                         | 44 511 660-00 |
|    | Brushed Platinum               | 44 511 660-06 |
|    | Platinum                       | 44 511 660-08 |
|    | Dark Chrome                    | 44 511 660-19 |
|    | Light Gold                     | 44 511 660-26 |
|    | Brushed Light Gold             | 44 511 660-27 |
|    | Brushed Durabronze (23kt Gold) | 44 511 660-28 |
|    | Matte Black                    | 44 511 660-33 |
|    | Brushed Bronze                 | 44 511 660-42 |
|   | Brushed Champagne (22kt Gold)  | 44 511 660-46 |
|  | Champagne (22kt Gold)          | 44 511 660-47 |
|  | Brushed Chrome                 | 44 511 660-93 |
|  | Brushed Dark Platinum          | 44 511 660-99 |

44 511 660

mm [inches]

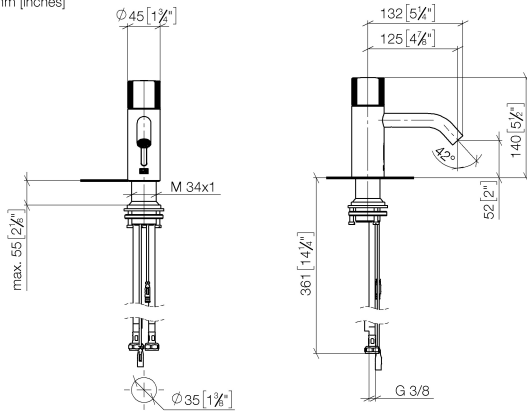

**Flow rate chart**

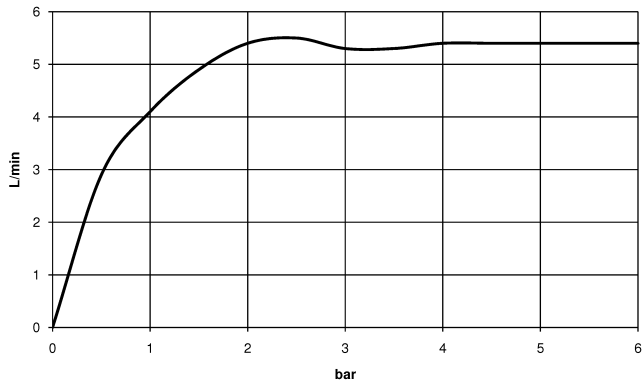

**Certificates**

LGA\_38243.

WRAS\_2212021.

44 511 660

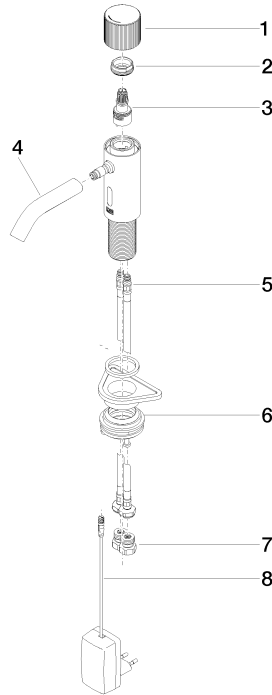

### Spare parts list

| No. | Item Number        | Name         | Quantity used | Delivery time |
|-----|--------------------|--------------|---------------|---------------|
| 1   | 90 20 66 124 00-00 | handle       | 1             | 10            |
| 2   | 09 24 04 562 90    | nut          | 1             | 60            |
| 3   | 90 90 03 173 00 90 | top          | 1             | 2             |
| 4   | 90 11 06 206 00-00 | spout        | 1             | 10            |
| 5   | 04 30 04 100 00 90 | hose         | 2             | 2             |
| 6   | 04 23 10 044 08 90 | fixing set   | 1             | 2             |
| 7   | 90 24 03 314 00 90 | nipple set   | 2             | 2             |
| 8   | 90 10 01 251 00 90 | power supply | 1             | 2             |